

Recording an airfoil profile polar in a wind tunnel

Objects of the experiment

- To measure the aerodynamic lift and drag for different angles of attack.
- To generate an airfoil profile's drag polar.
- To determine the angle of attack for best gliding.

Principles

A polar of an airfoil profile is a graph which visualizes important performance characteristics of an airfoil. The x-axis of a drag polar contains the values for the aerodynamic drag F_D . The y-axis contains the values for the aerodynamic lift F_L . The belonging angles of attack α are recorded as parameters.

In this experiment the angle of attack α for the best gliding angle γ is determined by means of a drag polar (see Fig. 2). The best gliding angle γ is directly visible in the polar plot (see Fig. 1). The point of contact between the steepest straight line through origin and the drag polar is called the point of best gliding. At the belonging angle of attack α the ratio of aerodynamic drag F_D to lift F_L becomes minimal.

$$\frac{F_D}{F_L} = \tan(\gamma) \quad (I)$$

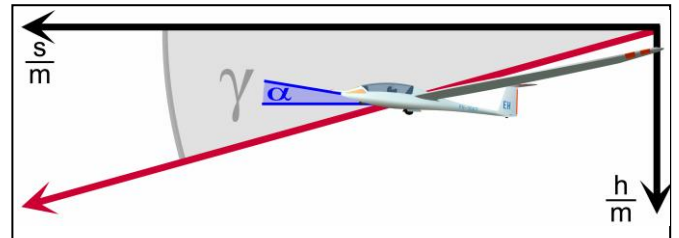

Fig. 2: Gliding angle γ and angle of attack α

The best gliding angle γ depends on the velocity.

The aerodynamic lift F_L is defined as the force component perpendicular to the direction of flow:

$$F_L = c_L \cdot A \cdot p_d \quad (II)$$

Lift coefficient: c_L

The area A denoted the horizontal airfoil area at an angle of attack $\alpha = 0^\circ$. The dynamic pressure is noted with p_d .

The aerodynamic drag F_D is defined as the force component against one object's relative direction of movement.

$$F_D = c_W \cdot A \cdot p_d \quad (III)$$

Drag coefficient: c_W

The reference area A is the same as for F_A . Thus the drag coefficient c_W is defined depending on the angle of attack α .

Fig. 1: Drag polar, schematically: best gliding angle γ , point of best gliding (1), lowest drag (2), zero lift (3), maximum lift (4)

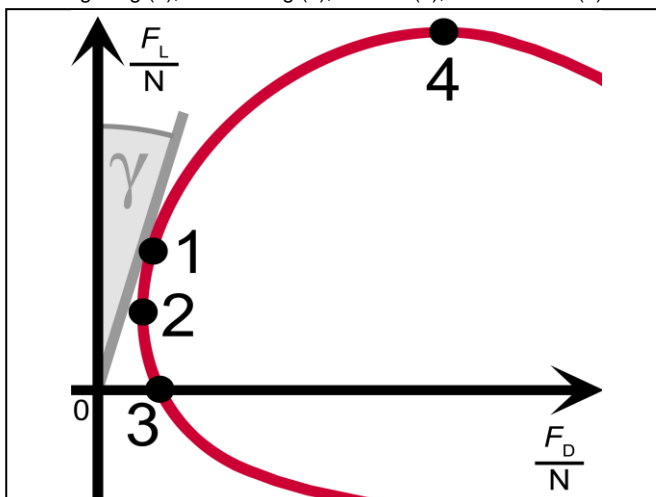

Remark: The classical Lilienthal polar is a $c_A(c_W)$ -graph. This form of notation is avoided here deliberately. A Lilienthal polar suggests to be independent of scale, area and dynamic pressure. These physical quantities depend on the flow velocity, the average density of air and further simplifying assumptions. Yet, together with the apparatus of P1.8.5.6 a Lilienthal polar can also be recorded here.

Apparatus

- 1 Suction and pressure fan..... 373 041
- 1 Wind tunnel..... 373 12
- 1 Measurement trolley for wind tunnel..... 373 075
- 1 Aerodynamics accessories 2..... 373 08
- 1 Sector dynamometer, 0.65 N..... 373 14

Optional:

- 1 CASSY Lab 2 524 220
- Additionally required: 1 PC with Windows XP or higher*

Safety notes

Mind the safety notes in the instruction sheets of the aerodynamics accessories 2 and the suction and pressure fan.

Before removing the protective grid or the nozzle:

- Pull out the mains plug and
- wait for at least 30 seconds until the suction and pressure fan comes to a complete stop.

Setup

Assemble apparatus as shown in Fig 3. Plug the suction side of the suction and pressure fan into the diffuser drawing the air in the wind tunnel. Ensure a clearance of at least 1 m before the suction nozzle of the wind tunnel and behind the suction and pressure fan for avoiding air turbulence.

- Align wind tunnel exactly horizontal.
- Insert the lamination filter (protection grid) into the slot at the entry gate.
- Carefully mount the lift balance on the measurement trolley and place it on the guide rail of wind tunnel's Plexiglas hood.
- Loosen the four securing screws for the floor of the wind tunnel and remove the level floor.
- Insert the airfoil of aerodynamics accessories 2 into the wind tunnel from below and stick the airfoil's pair of stay bars through the holes of the lift balance's attachment block for stay bars (see Fig. 3, close-up shot).
- Tighten the rear knurled screw of the lift balance when the rear stay bar's tip is exactly as high as the adjustment line. Tighten the front knurled screw when the adjustment scale shows an angle of attack $\alpha = 12^\circ$.

Remark: When changing the angle of attack during one series of measurements only ever loosen the front knurled screw of the attachment block in the lift balance! If the rear knurled screw is loosened the adjustment gets lost!

- Turn the knurled nut for setting zero point on top of the lift balance as long as the pointer of the lifting force indicates a lift of 0 N.
- Reattach the level floor of the wind tunnel.
- Connect the sector dynamometer's cord for the transfer of force to the hook of the measurement trolley so that the cord is horizontal. Check if the cord winds closely around the spring casing with groove for the cord.

Remark: For further hints refer to the instruction sheets 373 08 and 373 12.

Fig. 3: Experimental setup

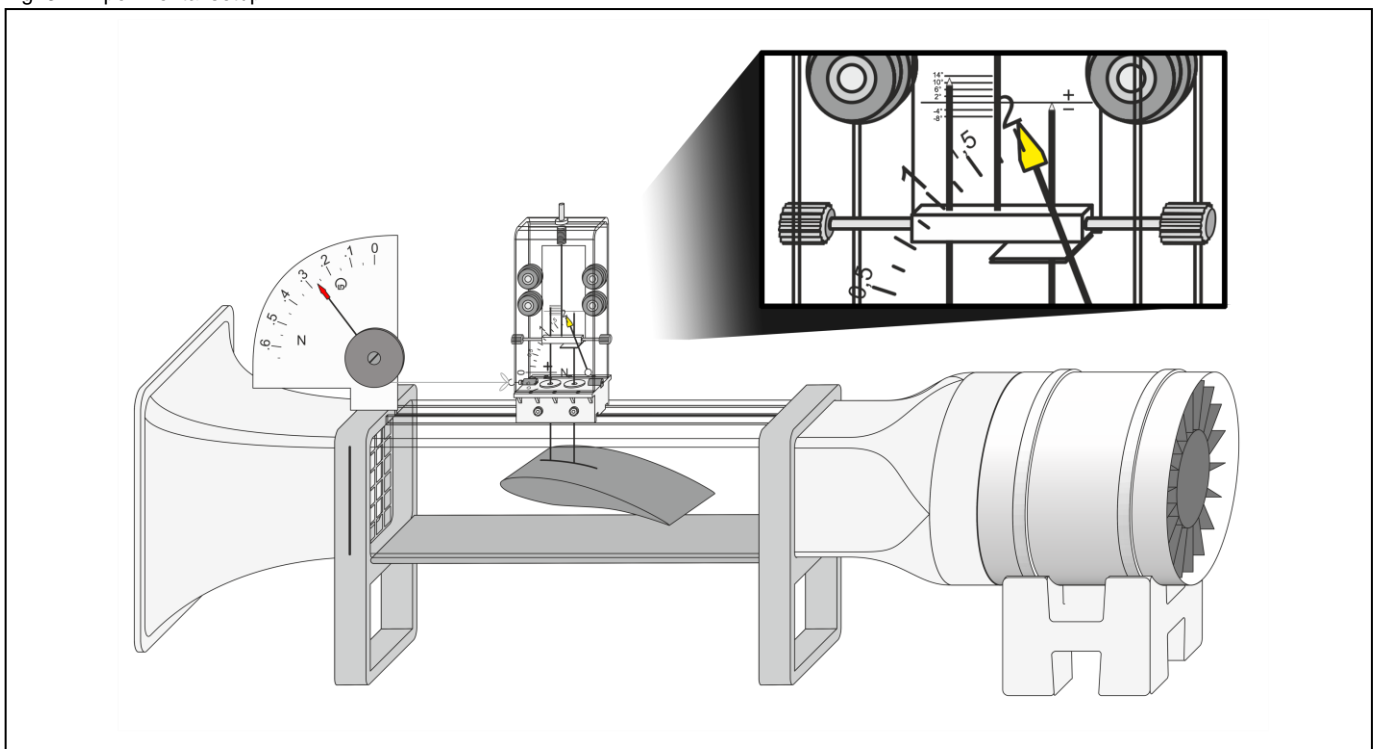

Carrying out the experiment

a) Measuring without CASSY Lab 2

- Set the suction and pressure fan to its minimum speed (i.e. left limit position of fan control) and only then switch it on.
- Slowly increase the speed of the suction and pressure fan until the sector dynamometer, 0.65 N comes close to its maximum or until the lift balance indicates 2.2 N.

Remark: For minimizing measurement errors due to friction: Push the measurement trolley a little against the direction of flow. Release the measurement trolley again. When the sector dynamometer's pointer stopped oscillating, first check if the cord is still in the groove of the spring casing. Repeat this step several times for estimating a good average value.



- Read off the aerodynamic drag F_D and lift F_A shortly after each other and note the values in a table together with the current angle of attack α .
- Move the clamp carrier from aerodynamics accessories 2 between the measurement trolley and the lift balance clamp the airfoil's pair of stay bars.
- Only loosen the front knurled screw of the lift balance and reduce the angle of attack α by 2° .
- Carefully tighten the front knurled screw again and take out the clamp carrier.
- Repeat the last four steps for further angles of attack until $\alpha = -6^\circ$ is reached.
- Transcribe the values in a graph of $F_A(F_W)$, connect the measuring points and label them with the belonging angle of attack α .

b) Measuring with CASSY Lab 2

- If not yet installed, install the software CASSY Lab 2 and open the software.
- [Load the settings in CASSY Lab 2.](#)
- Set the suction and pressure fan to its minimum speed (i.e. left limit position of fan control) and only then switch it on.
- Slowly increase the speed of the suction and pressure fan until the sector dynamometer, 0.65 N comes close to its maximum or until the lift balance indicates 2.2 N.

Remark: For minimizing measurement errors due to friction: Push the measurement trolley a little against the direction of flow. Release the measurement trolley again. When the sector dynamometer's pointer stopped oscillating, first check if the cord is still in the groove of the spring casing. Repeat this step several times for estimating a good average value.

- Read off the aerodynamic drag F_D and lift F_A shortly after each other and note the values in table "Drag Polar" of the CASSY Lab 2 window together with the current angle of attack α .
- Move the clamp carrier from aerodynamics accessories 2 between the measurement trolley and the lift balance. Clamp the airfoil's pair of stay bars.
- Only loosen the front knurled screw of the lift balance and reduce the angle of attack α by 2° .
- Carefully tighten the front knurled screw again and take out the clamp carrier.
- Repeat the last four steps for further angles of attack until $\alpha = -6^\circ$ is reached.

Remark: To record more than the prepared measurement series open "Measurement" in the menu bar and select  "Append new Measurement Series". Select table "Drag polar" and click  once. Open the  "Settings" pane and mark "Drag polar" in the submenu "Displays". Push the button "Add new Curve" and select "F_L#2" in the drop down menu for "y-axis". Choose "F_D#2" in the drop down menu for "x-axis".

Measuring example

$\frac{\alpha}{^\circ}$	$\frac{F_D}{N}$	$\frac{F_L}{N}$
12	0.62	2.3
10	0.50	2.1
8	0.40	1.7
6	0.33	1.5
4	0.25	1.1
2	0.18	0.7
0	0.15	0.5
-2	0.12	0.2
-4	0.10	-0.1
-6	0.12	-0.4

Tab. 1: Angle of attack α , aerodynamic drag F_D and lift F_L of the airfoil profile in the wind tunnel.

Evaluation and results

The steepest straight line through origin that touches the imaginary polar curve corresponds with an angle of attack $\alpha = +6^\circ$ (see Fig 4).

Fig. 4 allows to construct the best gliding angle γ for the given flow velocity (mind the different scales!). Alternatively the best gliding angle γ can be calculated with equation (I):

$$\gamma = \tan^{-1}\left(\frac{0.33}{1.5}\right) = 12^\circ$$

The lowest aerodynamic drag is found at an angle of attack $\alpha = -4^\circ$ and not at $\alpha = 0^\circ$. This is typically for asymmetric profiles.

Zero lift is generated somewhere between $\alpha = -4^\circ$ and $\alpha = -2^\circ$. Important for parabola flights simulating weightlessness.

Maximum lift was not yet exceeded at an angle of attack $\alpha = +12^\circ$. Hence no aerodynamic stall was produced.

Alternatively the drag polar can be resolved:

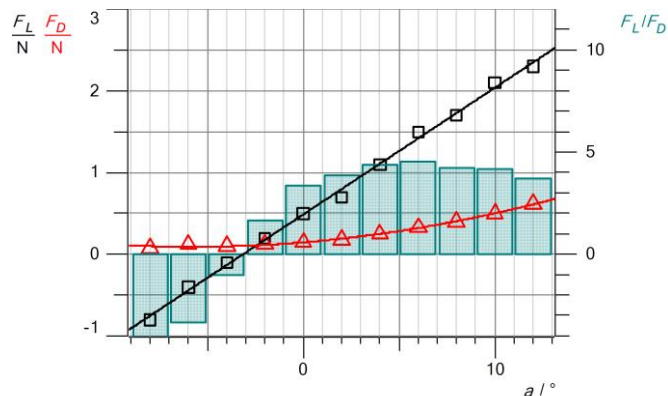

Fig. 5 Aerodynamic lift F_L , drag F_D and F_L/F_D as a function of the angle of attack α .

Fig. 4: Polar curve with measuring values of Tab. 1.

